



User Manual

Table of Contents

1. Your Mobile

- 1.1 Getting to know your phone
- 1.2 Removing the back cover
- 1.3 Installing the SIM card
- 1.4 Installing and charging the battery
- 1.5 Installing a microSD card
- 1.6 Setting up your phone for the first time
- 1.7 Home Screen
- 1.8 Using the touchscreen
- 1.9 Lock / Unlock your screen
- 1.10 Using the Hard Keys
- 1.11 Notification panel (Status bar)
- 1.12 Quick Settings
- 1.13 Search bar

2. Text Messaging, MMS & Gmail

- 2.1 Sending a new text
- 2.2 Sending a new MMS
- 2.3 Sending messages to a group
- 2.4 Manage messages

- 2.5 Adjust message settings
- 2.6 Gmail set-up
- 2.7 Sending an email
- 2.8 Receive and read emails

3. Phone Calls

- 3.1 Making a call
- 3.2 Answering or rejecting a call
- 3.3 Calling Voicemail
- 3.4 During a call
- 3.5 Managing a two-way call and conference call
- 3.6 Call Settings

4. Contacts

- 4.1 View a contact
- 4.2 Adding a contact
- 4.3 Editing Contacts
- 4.4 Importing, exporting and sharing contacts
- 4.5 Displaying contacts
- 4.6 Synchronising contacts in multiple accounts

5. Wi-Fi

- 5.1 Turn Wi-Fi on and add a Wi-Fi network
- 5.2 Connecting to other Wi-Fi networks
- 5.3 To forget a Wi-Fi network

6. Bluetooth

- 6.1 Turn on Bluetooth
- 6.2 Pair or Connect your phone with a Bluetooth device

6.3 Disconnect or Unpair from a Bluetooth device

7. Connecting to a computer via USB

8. Calendar

8.1 Viewing mode

8.2 Create a new event

9. Clock

9.1 Alarm

10. Calculator

11. Camera and Gallery

11.1 Take a picture

11.2 Shoot a video

11.3 Camera settings

11.4 Video settings

11.5 Gallery

11.6 Editing pictures

11.7 Share a picture or video

12. FM Radio

13. Music

14. Google Play store

15. Google Duo

16. Files

17. Sound Recorder

18. Settings

18.1 Network & Internet

18.2 Connected devices

18.3 Apps & Notifications

18.4 Battery

18.5 Display

18.6 Scheduled power on / off

18.7 Navigation bar

18.8 Audio profiles

18.9 Storage

18.10 Security & location

18.11 Accounts

18.12 Accessibility

18.13 Digital Wellbeing and parental controls

18.14 Google

18.15 System

1. Your Mobile

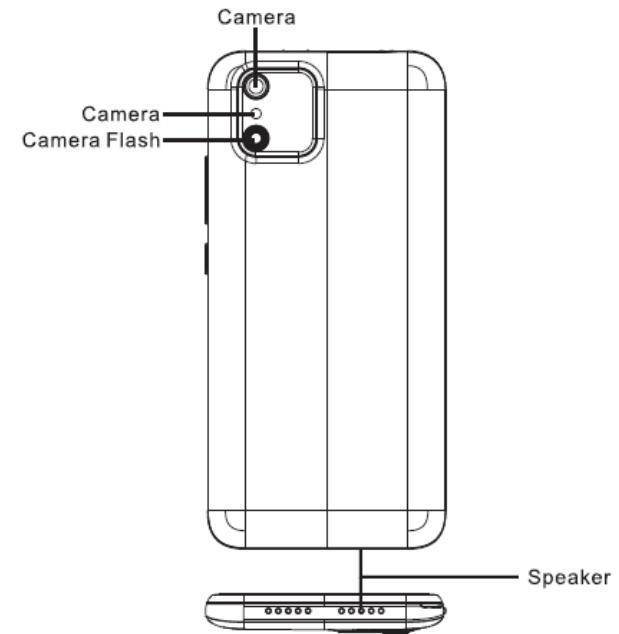
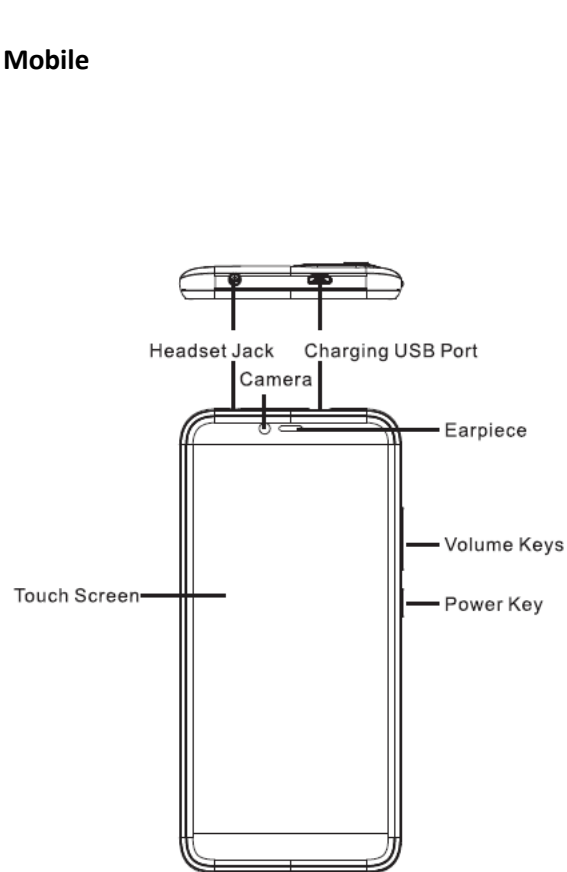

1.1 Getting to know your phone

Power Key:

- Press and hold to turn on the phone. When phone is on press and hold until options are displayed.
- Select Power off and then OK to turn off the phone.
- Select Restart to power off and turn the phone back on.
- Press and hold while also holding volume decrease key to take a screenshot .

Home Key:

- Touch to return to the home screen when in any app or screen.
- Touch and hold to open the Google Assistant for Android.

Recent Key:

- This shows your recently-used apps. Touch an image to open it or swipe it up to remove it from the list

Back Key:

- Touch to go back to the previous screen or to close a dialogue box, options menu, the notification panel etc

These buttons are always visible when you use the screen.

Volume Keys:

- Press or hold to increase or decrease the volume of the earpiece or headset.
- In general mode these keys also adjust the ringtone volume.
- Can also mute the ringtone of an incoming call.

1.2 Removing the back cover

With the screen facing down unclip the back cover of your IMO Q4 Pro from the bottom left corner. There is a small indent in the cover to assist you.

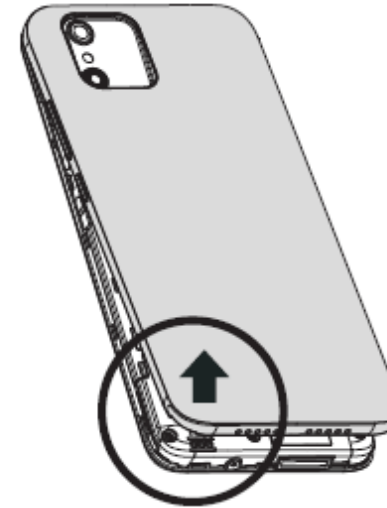

1.3 Installing the SIM card

To insert your SIM card, make sure the corner of the SIM card with the triangular edge missing is on the top right, and insert into the slot as shown in the diagram below.

Your phone only supports nano-SIM card. Do not attempt to insert other SIM types like micro or mini cards otherwise you may damage your phone.

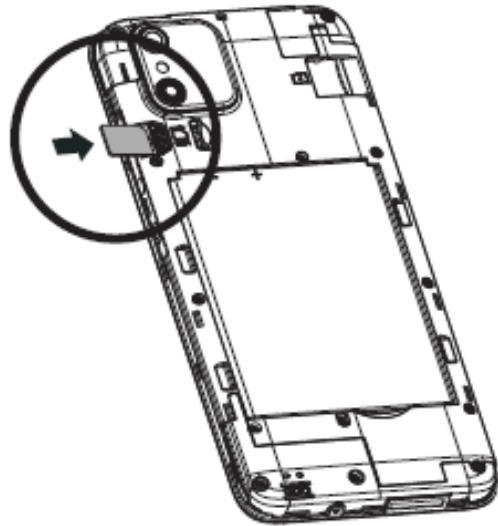

1.4 Installing and charging the battery

After your SIM card has been installed, you can now insert your battery. Please make sure the 3 gold connecting pins are aligned on the top left of the battery with the 3 connection pins on the handset. Now securely clip the back cover back onto your handset.

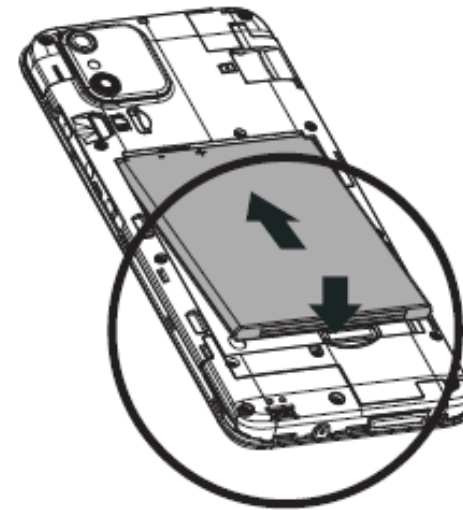

To charge the battery, connect the small end of the USB charging cable to your phone using the Micro USB port at the top of the phone. Connect the other end to the plug and insert into mains socket to start charging your phone. We recommend charging your device fully before you fully set up your phone. This should take around 1 hour.

To reduce your phone's power consumption you can switch off Wi-Fi, GPS, Bluetooth or apps running in the background when not needed. In settings you can also lower the brightness of the screen and shorten the length of time before the screen goes to sleep

1.5 Installing a microSD card (not included)

Insert a microSD card as shown in the diagram below.

Note some applications may require a microSD card to work and may save data on it. Therefore it is recommended you keep the microSD card installed and do not remove or replace it randomly.

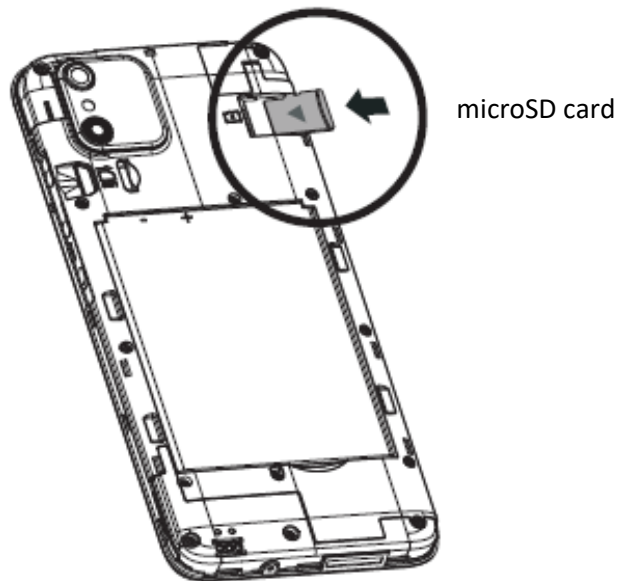

1.6 Setting up your phone for the first time

- The first time you power on your phone you will be asked to set language, mobile network, Wi-Fi, date and time.
- Select the phone's language, then touch **START**.
- Insert the SIM or press **SKIP**.

- Select a Wi-Fi network or touch **SKIP** and then continue.
- Select if you want to copy apps and data or start as new.
- Sign in with your Google account if you already have one or if you do not have an account already touch **Create a new account** or press **Skip**.
- Read Google Services and then **ACCEPT**
- Protect your phone, set the screen lock option you wish using Fingerprint only, Fingerprint and pattern/PIN/Password or select **SKIP**.

1.7 Home Screen

- Touching the **Home** button always takes you to your main Home screen and you can personalise all your Home screens by adding your favourite apps, shortcuts and widgets to them.
- Status bar: Displays notifications and status icons. Touch and drag down to open the Notification panel.

1.8 Using the touchscreen

- Touch to launch applications and other functions.
- Touch and hold for more than 2 seconds to open the control options for the current screen.
- Touch and hold an item to be able to drag it to another location.

- Slide / Swipe to view information, applications etc.
- Pinch / Spread to zoom in and zoom out.
- Rotate to change the screen from portrait to landscape by turning the phone sideways.

1.9 Lock / Unlock your screen

- Locking the phone turns the screen off and stops any unwanted actions. To lock the screen while using the phone just press the Power key.



- To unlock it, press the Power key, drag the icon upwards.
- You can lock your phone screen with patterns, PIN, password or Face Lock. To do this, go to **Settings > Security & Location > Screen lock**. Choose the option you would like to set following the onscreen instructions.
- For ease of use, you can unlock your phone using facial recognition by simply looking at it.
- To set-up facial recognition select **Face Lock** and follow the on-screen instructions.
- **NOTE:** Face-matching is less secure than a pattern, PIN or password. Someone who looks like you, or who has a photo or video of you maybe able to unlock your phone.

1.10 Using the Hard keys

- Volume keys during a call these keys will adjust the volume of the earpiece or headset. In Music/Video/Streaming mode these will adjust the media volume. These keys adjust the ringtone volume and will mute the ringtone of an incoming call.
- Power Key – Press and hold, turns the phone off / on. Press to activate the lock screen / wake-up screen. Long press, displays the options: **Power off, Restart, Screenshot**.
- Alternatively long press the **Power** key and the **Volume down** key to capture a screenshot.

1.11 Notification panel

Pull down the Status bar to open the Notification panel. Here you can view network information, new events, shortcuts to settings. From this panel you can quickly open and close applications, clear all notifications. Pull up from the bottom of the panel to close.

1.12 Quick Settings

Dragging down the status bar opens the Quick Settings panel. In the panel you can configure the following settings:

- Brightness.
- Check Wi-Fi settings, long press to turn Wi-Fi on or off.

- Open Bluetooth settings, long press to turn. Bluetooth on or off.
- Do not disturb.
- Turn on Wi-Fi calling.
- Turn Torchlight on/off.
- Portrait/Auto-rotate mode for screen view.
- Change Mobile data usage.
- Turn Aeroplane mode on / off.

If you touch the edit icon  at the bottom right of the panel you can edit the settings displayed to add / remove from the Quick settings panel. Further settings available are:

- Turn Location on / off.
- Smart saving mode.
- Hotspot.
- Invert colours.
- Data saver.
- Storage.

In Quick settings panel, touch



to access **Settings**.

1.13 Search bar

The phone provides a Search function which can be used to locate information within applications, the phone or the web.

Search by text

- Touch the Search bar from the Home screen
- Enter the text/phrase you want to search for.
- Touch  on the keyboard if you want to search the web.

Search by voice

- Touch  from Search bar to display a dialog screen.
- Speak the word/phrase you want to search for. A list of search results will display for you to select from.

2. Text Messaging, MMS & Gmail

Your phone can create, edit and receive chat, SMS and MMS messages.

2.1 Sending a new text

To send a text to a certain phone number

- Go to the Home page and touch the  icon in the Favourites tray.

- In the message list screen, touch the start chat icon to write new text / multimedia messages.

- Click "type a name, phone number, or email address" box to start the input method. Enter a phone number or name of contact or select from 'Top Contacts'.

- Write the information you want.

- Click the  button and your message will be sent.

2.2 Sending a new MMS

When creating a message it will automatically default to an SMS.

To send an MMS select the photo from the gallery application and touch the share icon.

- Select Messages, you will be given an option of recent conversations or select 'New message'.

- Add text to the message if required.

- Click the  button and your MMS will be sent.

2.3 Sending messages to a group of Contacts

- In the message list screen, touch the start chat icon to write new text / multimedia messages.

- Select 'Start group conversation'.

- Click "type a name, phone number, or email address" box to start the input method. Enter group numbers in the box by manually entering the phone number or choose by contacts.

- Write the information you want.

- Click the  button and your message will be sent. If the message failed to send a red circle with an exclamation mark will appear.

2.4 Manage messages



When a new message arrives, an  icon will be shown on the status bar as a notification. Pull down the status bar to open the Notification panel, touch the new message to open it. You can also open it via the messages application.

Messages are displayed as conversations.

To reply to a message, touch the received message to enter the

message composing screen, enter the text, then click the  button.

If you long press a message in the message details screen you will be given options to archive, delete, Add to Contacts, block the selected number. If you choose to block the number you will not receive any calls or texts from this number.

2.5 Adjust message settings



In the message list screen, touch  and select **Settings**. You will see the following options:

- **Chat Features:** these settings allow you to enable chat features such as using Wi-Fi or data for messages. You can set read receipts, let others know you are typing, resend messages if undelivered. You can select to auto-download files over mobile.

- **Notifications:** Touch on/off to turn on notifications for Messages.

Other notifications: Behaviour allows you to choose the notification type for incoming messages.

Advanced: Touch to set additional settings for messages. Choose if you want to show notifications when Do Not Disturb mode is enabled.

- **Additional settings in the app:** touch to set additional settings for Messages.

- **Hear outgoing message sounds:** Touch to enable/disable to hear message sounds when you send a message.

- **Your current country:** Touch to choose your current country.

Advanced:

- **Group messaging:** Mark the checkbox to send a single message to multiple recipients.
Auto-download MMS: Touch to enable/disable the automatic download of MMS.
- **Auto-download MMS when roaming:** Touch to enable/disable the automatic download of MMS when roaming.
- **Use simple characters:** Touch to enable/disable the use of simple characters in MMS.

- **Get SMS delivery reports:** Touch to enable/disable confirmation that SMS has been delivered.
- **Spam protection:** Touch to enable/disable spam protection.
- **Wireless alerts:** Touch to access wireless alert settings.
- **SIM card messages:** Touch to view messages on SIM card.
- **Phone number:** Show your phone number.

2.6 Gmail set-up

The first time you set up your phone, you can choose to use an existing Gmail account or to create a new Email account. Gmail is configured when you first set up your phone and can be automatically synchronised with your Gmail account on the internet. Each email and its replies will be grouped in your inbox as single conversations.

You can activate or edit existing e-mail accounts as well as create a new e-mail account.

To set up a new Gmail account or another email account you need to access the Gmail app, touch the Application tab and select > **Gmail**

You are provided with the option to **Add another email address**. You can add or set-up external email accounts, some options are already provided **Google, Outlook, Hotmail and Live, Yahoo, Exchange and Office 365** or **other**. When you have completed the steps to add

another email account you are able to switch to another account by touching the account name from the Inbox screen.

2.7 Sending an email.

- Touch the pen icon from the Inbox screen.
- Enter the recipients email address in the **To** field.
- If required, touch the popup menu (down arrow) icon **Add Cc/Bcc.**
- Enter the subject and the content of the message.
- Touch the paperclip icon to add an attachment.
- When finished press the send icon to send the email.
- To add a signature to emails, touch the  icon, touch **Settings** from the Inbox, choose an account, then select **Mobile Signature.**

2.8 Receive and read emails

When you receive a new email you will get a notification by either a ringtone or vibration and an icon will be displayed on the Status bar. Drag down the Status bar to display the Notification panel. Select the new email to view it. You can also view the email via the Gmail app.

3 Phone Calls

3.1 Making a call

To make a call when the phone is active, go to the Home

screen and touch the phone  icon in the Favourites tray. Enter the phone number you want into the dial pad directly by touching the dial pad in the centre or bottom right

of the screen or select contact from **Favourites, Recent, Contacts** by touching tabs, then touch (phone icon) to activate the call.

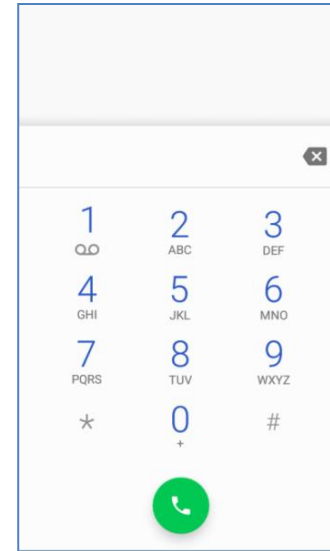

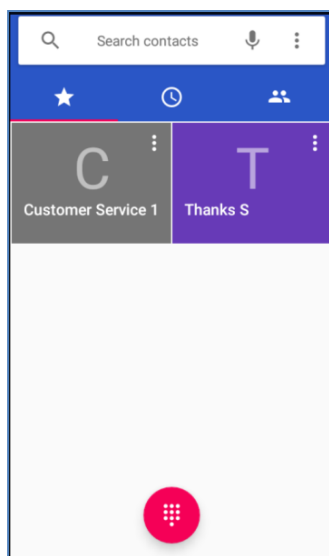

The number you enter can be saved to **Contacts** by touching the **“Create new contact”** or **“Add to a contact”** option. You can send an SMS to the number if you want.

If you make a mistake, you can delete any incorrect digits by touching the **“backspace”** button.

To finish a call touch the **“hang up”** button.

Every number called and received will be stored in the phone’s call log. All numbers in the call log can be dialed by clicking the **“dial”** button on the right side of the screen.

When the number list is shown you can click on a number to see options to **Create a new contact**, **Add to a contact**, **Send a**

message, **Block number**, **Call details**. If you touch Call details you can Copy, Edit, Delete the number.

To make an **International Call** long press 0 to enter **“+”**, then enter the international country prefix code followed by the full phone number, then touch the dial to make the call.

If your phone has network coverage dial the emergency number and touch dial to make an emergency call. This will work even if the phone does not have a SIM card.

3.2 Answering or rejecting a call

When you receive a call touch **ANSWER** to answer the call or **DECLINE** to reject the call. If your phone screen is locked when you receive a call swipe up to answer the call.



Swipe the icon in the lower left corner to decline the call with a message. The call will not be answered and the caller will receive a corresponding text message.

To mute incoming calls, press the **Volume up/down** key.

3.3 Calling Voicemail

Voicemail is a service provided by your network operator. To set your voicemail number touch the  key, then touch **Settings > Voicemail > Advanced settings** and touch **Setup**. To listen to your voicemail long press **“1”** on **Phone** tab.

3.4 During a call

Your phone has a proximity sensor and using the distance between the phone and the body it will automatically adjust the backlight.

During a call the backlight will turn off automatically, which could save batteries and prevent inadvertent touching of keys on the phone.

To adjust the volume during a call, press the **Volume up/down** key.

3.5 Managing a two-way call and conference call

Your phone can manage multiple calls at the same time. Please note your network operator needs to support two-way and conference calling features.



You can set up a conference call by clicking on  and dial another call or if receive another call, the phone will default and open "call waiting".



Telephone recording during a call, Click  to record the call.

3.6 Call Settings



From the Phone screen, touch the  key and select **Settings**. The following options are available:

- **Display options:** Touch to sort contacts display by First name or Last name.
- **Quick responses:** Touch to edit the quick response text messages which will be used when you reject a call with messages.
- **Calls:** Touch to set Fixed Dialling Number (Operator dependent), Touch enable/disable Wi-Fi calling, Touch enable/disable video calling. Call forwarding options when you are busy, not able to answer or unreachable. Call barring and Additional Settings
- **Voicemail:** Touch to set voicemail number and voicemail notifications when a voicemail is received.
- **Accessibility:** Touch to enable/disable hearing-aid compatibility.
- **Call Recording:** Touch to enable/disable automatic recording.
- **Flip to silence call:** Touch to activate this feature.
- **Fast dial settings:** Choose the fast dial settings you want.
- **Prompts for call connection:** Touch to activate vibration feedback for outgoing calls and upon call disconnection.
- **Fade-in ringer:** Touch to enable this feature.



Other options available when you touch  in the phone screen are:

- **Call history:** Displays recent calls made from the phone application.
- **Call Blocking:** Touch to add the number of contacts you don't want to receive by phone or text message. See the numbers you have blocked.

4. Contacts

You can view and create contacts on your phone and synchronise these with your Gmail contacts or other apps or on your phone.

4.1 View your Contacts

To access the **Contacts** app, touch the Application tab and

select > **Contacts** .

The default setting will display your mobile phone contacts and SIM card contacts.

4.2 Adding a Contact

Touch the Application tab on the Home screen, select



Contacts, then touch the  icon in the contact list to create a new contact. The first time you do this you will be prompted to select a default account for new contacts: **Google account, Phone** or **SIM card**.

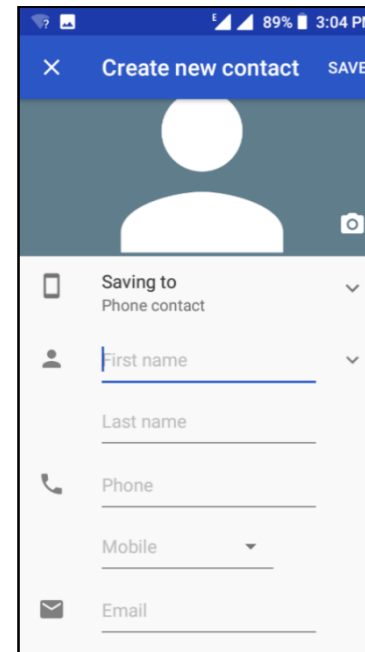

To add a contact to favourites, you can touch a contact to view details then touch the “star” key to add the contact to your favourites. To remove a contact from favourites, touch the “star” key on the contact details screen.

4.3 Editing Contacts



To edit contact information touch the pencil icon in the contact details screen. When finished touch **SAVE**.

4.4 Importing, exporting and sharing contacts

In the Contact display, click on the Menu button , touch **Settings** then touch **Import/Export contacts** to import/export contacts from/to your SIM card, Phone, Accounts, Internal storage etc.

To import / export a single contact from / to your SIM card. Choose an account and SIM card, select the contact you want and touch **OK** to confirm.

To import/export all contacts from/to your SIM card, choose an account, select SIM card, touch **Select all** and touch **OK** to confirm.

You can share a single contact or multiple contacts with others via Bluetooth, Gmail etc. To do this touch a contact  you want to share, touch  and **Share**. Select how you wish to share the contact via **Messages, Gmail, Bluetooth** or other.

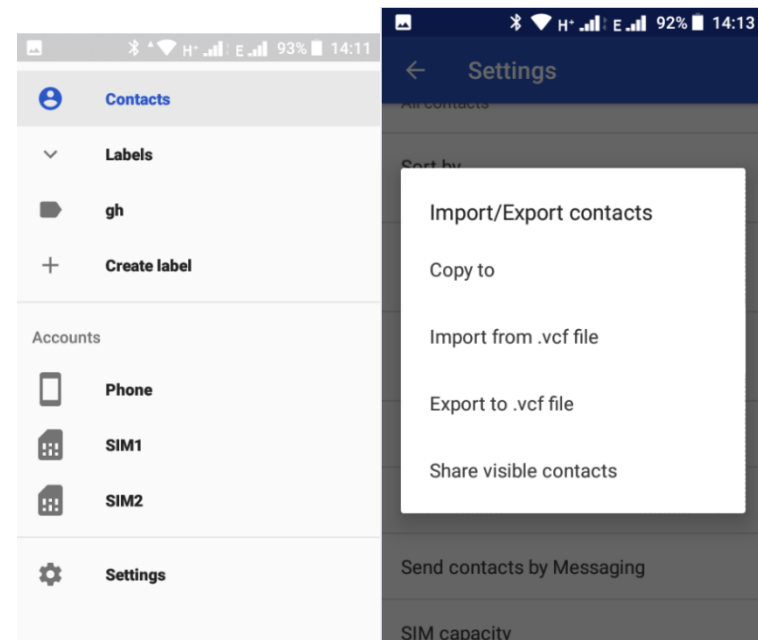

4.5 Displaying contacts

You can decide which group of contacts you want to display in the Contact list. Touch the Menu key  then touch **Settings**, then **Contacts to display** from the Contacts list screen, then you can choose which contacts to display.

4.6 Synchronising contacts in multiple accounts

Contacts, data and other information can be synchronised across multiple accounts depending on the apps installed on

your phone. To add an account touch  icon on the Quick Settings bar to get to **Settings**, then touch **Accounts**. Select the account you are adding such as Google, Exchange. As with other account set-ups you will need to enter information such as username, password etc.

You can remove an account and all associated information from the phone. Open the **Settings** screen, touch the account you wish to delete then touch **REMOVE ACCOUNT** to confirm.

You can synchronise an account on **Accounts** screen, touch



beside Automatically sync data.

5 Wi-Fi

You can connect to the internet when your phone is in range of a wireless network. Wi-Fi can be used on your phone even if a SIM card is not inserted.

5.1 Turn Wi-Fi on and add a Wi-Fi network

- Touch the settings button in **Quick Settings** to go to the Settings menu, then touch **Network & Internet > Wi-Fi**.
- Touch the button to turn on/off Wi-Fi.
- Turn on Wi-Fi: information regarding all nearby detected networks is displayed in the Wi-Fi networks section.

The  symbol will show when there are open available networks to connect to.

- Touch a Wi-Fi network to connect to it. If the network is secure you will be asked for the password (or other security information, contact the network provider for these details). When you are finished touch **“Connect”**. When successfully connected you will see  symbol in the status bar.

Unless you choose to forget the network, your phone will search automatically for your saved Wi-Fi networks when you are in range.

5.2 Connecting to other Wi-Fi networks

In the Network & Internet menu, touch **Wi-Fi**. The connected Wi-Fi network will show on the Wi-Fi network list. Touch **Saved networks** to see other networks you have previously connected to and touch to select to change and connect to that network. Touching **Add network** enables you to add Wi-Fi network settings manually.

5.3 To forget a Wi-Fi network

Turn on Wi-Fi. In the Wi-Fi screen long press the name of the saved network. Touch **Forget**.

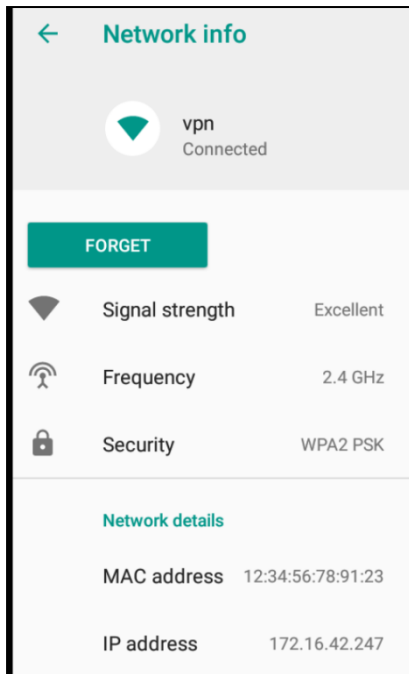

6. Bluetooth

Bluetooth is a short-range wireless communication technology that you can use to exchange data or to connect to other Bluetooth devices for various uses.

To access the Bluetooth function touch the  icon in the Quick settings bar to get to **Settings**, then touch **Connected devices**. Your device and other available ones will be displayed in the list.

6.1 Turn on Bluetooth



In the **Connected devices** option of **Settings**, select **Pair new device** and the Bluetooth phone function will turn itself on. Alternatively you can turn Bluetooth on via the **Quick settings** bar from the home screen by touching the Bluetooth button. You can name your phone to make it easier to recognise. This name will be visible to others. To do this select **Pair new device**, touch **Device name**, you will see a pop up which enables you to delete the existing name and rename the device.

6.2 Pair or Connect your phone with a Bluetooth device

- To exchange data with another device you need to first turn Bluetooth on and pair your phone with the Bluetooth device that you wish to exchange data with.
- Touch **Pair new device**, all available devices found will show in the list.
- Touch a device you wish to pair with. Note generally devices need a password to pair, sometimes this can be set to a default of '0000'
- A dialogue box will pop up, touch **PAIR** to confirm
- If pairing is successful your phone connects to the device. The



will show in the Status bar.

6.3 Disconnect / unpair from a Bluetooth device

- Touch  icon after the device you want to unpair and touch **FORGET**.

7. Connecting to a Computer via USB

With a USB cable you can transfer media files such as music and photographs and other files between your phone and a computer. To do this you need to set your phone as a drive.

- Connect the phone to the computer with a USB cable. A notification icon will appear in the status bar that the USB is connected.
- Open the Notification panel and select **Media device (MTP)** option. The phone is now connected as a media device to your computer.

To locate data you have transferred or downloaded in the internal storage touch the Application tab from the Home screen to open the apps list.

- Touch **Files**. All data you have downloaded is stored in Files, where you can view media files (videos, photos, music and others), rename files, install apps onto your phone, etc.

8. Calendar

The calendar application can be used to keep track of meetings, appointments and events. To access this function, touch the Application tab from the Home screen, then touch **Calendar**.

8.1 Viewing Mode

Once you are in the calendar program, click on . This will display Schedule and 4 options for viewing mode Day, 3-Days, Week and Month. The search option allows you to enter a schedule keyword in the search box and it will search the calendar for this item

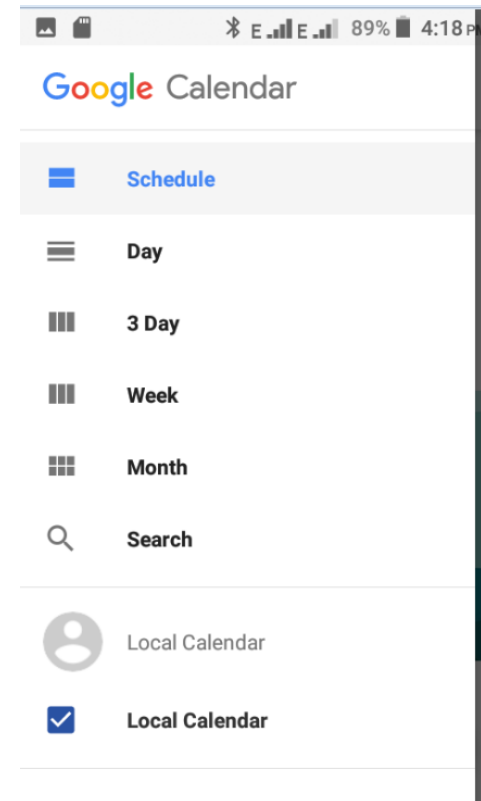



8.2 To create a new event

Touch  and choose **Goal**, **Reminder** or **Event**. Complete the information required. You can set for 'All-day' if required. When finished touch **Save** at the top of the screen.

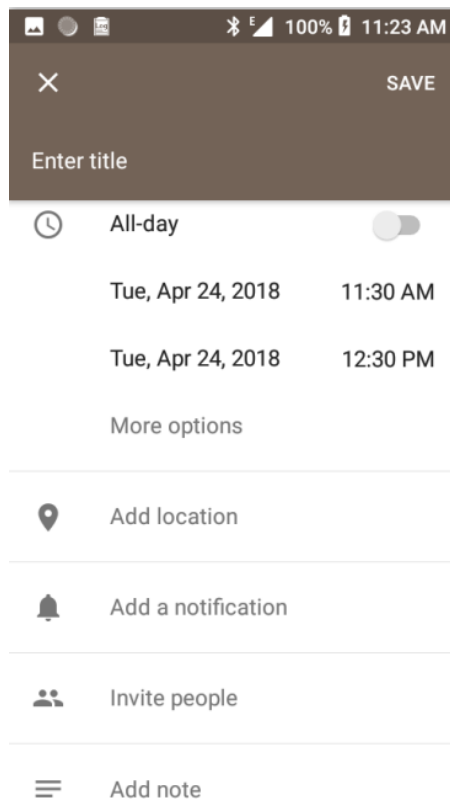
Note before you can add an event you must have at least one Calendar account.



To delete or edit an event touch the pen icon and edit the event or touch   and select **Delete** to delete an event.

Event reminders will show if set for an event as a notification in the Status bar when the time arrives.

9 Clock

Your phone has a built-in Clock. To access this touch the Application

tab from the Home screen then touch **Clock** . Within this app you can set a timer and stopwatch.

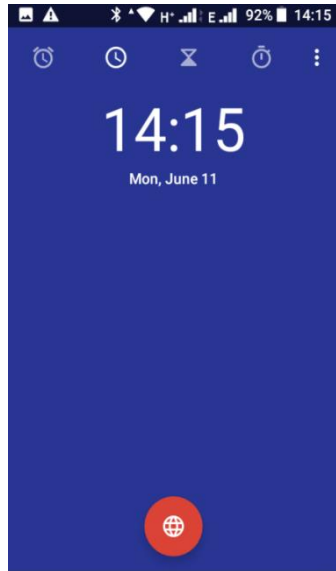

9.1 Alarm

Touch  to add or set an alarm.

From the Alarm screen touch  to add a new alarm. You will see the following options:

- **Time:** Set the time for your alarm. Touch  next to the time you have set to turn the alarm of/off.
- **Repeat:** Mark the checkbox to set a repeat mode, select the days you want the alarm to be repeated.
- **Ringtone:** Touch to select an alarm ringtone.

- **Vibrate:** Mark the checkbox to set vibrate.
- **Label:** Touch to set a name for the alarm.
- Touch **Silence after 10 minutes** to enable this feature
- Touch the **Trash bin** to delete the alarm

To adjust alarm settings touch **Settings** from the  icon, the following options will be available:

Clock:

- **Style:** touch to set analogue or digital.
- **Automatic home clock:** touch to set to home clock while travelling outside zone.
- **Home time zone:** touch to set home time zone.
- **Change date & time:** touch to set date and time.

Alarms:

- **Snooze length:** touch to choose length of snooze.
- **Alarm volume:** touch to set alarm tone volume.
- **Gradually increase volume:** touch to set gradually increased volume.
- **Volume buttons:** touch to choose **Control volume**, **Snooze**, or **Dismiss** as volume buttons.
- **Start week on:** touch to select the first day of a week from Sunday, Saturday, Monday.

Timers:

- **Timer ringtone:** touch to select time sound.

- **Gradually increase volume:** touch to set gradually increased volume.

10 Calculator

To open the Calculator touch the Application tab from the Home

screen then touch **Calculator** .

There are 2 calculator screens available. In the calculator menu, swipe the right-hand side of the screen and the advanced panel will be shown.

To view the calculation history drag down the top of the screen.

11 Camera & Gallery

Your mobile phone has a camera for taking photos and recording video. Before using the camera ensure you have removed any protective film from the lens. Install the memory card before using the camera or video camera.

To take a photo when your phone is active, touch Camera  in the favourites tray on your Home screen. If the phone is locked press the Power button and swipe the camera icon to the left to open the camera.

You can view photos and videos when in camera or video menu by touching the preview screen on the right-hand side of the main camera / video screen.

11.1 Take a picture

Your phone screen acts as the viewfinder. Position the object or landscape in the viewfinder, touch the shutter button to take a picture which will be automatically saved.

11.2 Shoot a Video

Touch  to change from camera mode to Video.

Touch  to start recording a video.

Touch pause in the bottom right-hand corner of the screen to pause recording a video.

Touch Stop button to finish recording a video and save to memory.

11.3 Camera settings

Select camera mode and at the top of the screen you will find the following settings you can use to enhance your photography including:

- **Flash:** Touch to set option on/off/automatic
- **HDR:** Touch to enable/disable.
- **Camera type:** Touch to switch between front and rear camera options.

Swipe left in camera mode and you have the more options which you can select according to your photography needs including **Auto, Manual, Burst mode, Panorama, Filter, QR code and Night-Shot.**

Swipe right in camera mode and you are in Camera Settings where you can select the settings below:

- **Volume key:** Touch to set option for keys for shutter sound
- **Quick capture**
- **Camera sound on/off**
- **Save location:** Touch to enable storing of phone GPS location information

In Photo settings you can set:

- **Picture size**
- **Picture quality**
- **Countdown duration**
- **Composition line**
- **AI detect**
- **Antibanding**
- **Touching photograph**

11.4 Video Settings

Select video mode and at the top of the screen you will find the following settings:

- **Flash:** Touch to set option on/off/automatic
- **Camera type:** Touch to switch between front and rear camera options.

Swipe left in video mode and you have the more options which you can select according to your video needs including **Time Lapse, Slow motion and Night-Shot.**

Swipe right in camera mode and you are in Camera Settings where you can select the settings below:

- **Volume key:** Touch to set option for keys for shutter sound
- **Quick capture**
- **Camera sound on/off**
- **Save location:** Touch to enable storing of phone GPS location information

In Photo settings you can set:

- **Video size**
- **Composition line**
- **White balance**
- **Antibanding**
- **Microphone on/off**

11.5 Gallery

Your photos and videos are stored in the Gallery application. To access this function, touch the Application tab from the Home screen, then touch **Gallery.**

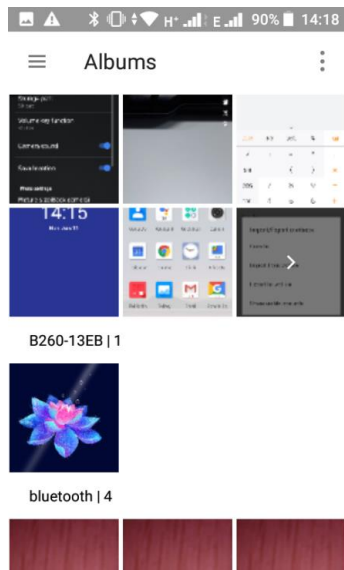

Touch the menu button on the top right of the Gallery screen and you can select to see all albums, photos and videos or select to see only photos, videos or albums.

11.6 Editing pictures

You can edit pictures, add effects, crop, share and set as a contact photo or wallpaper. To do this select the photo you want, touch the edit button available in the lower part of the screen to edit the photo.

Touching the icons at the bottom of the screen allows you to change effects, borders, crop, rotate, draw and adjust exposure settings and effects as you choose.

11.7 Share a photo or video

You are able to share photo's and videos from your phone by email, Bluetooth or using social media messaging and apps you may have installed on your device.

- To share a photo or video select the chosen photo/video thumbnail/s in the galley view by a long press on the thumbnail.
- Touch the share icon, the methods to send will be displayed. Touch the option you wish to send the content by and complete the action.
- To attach photo's or videos from the email application click on the paperclip icon when creating a new email and chose the photo from the selection.

12 FM Radio





Your phone has an in-built FM radio. The wired headset supplied with the phone acts as an antenna, please insert the headset into the device to enable the radio function. When listening to the radio you can switch to speaker mode if required.

To access the radio, touch the Application tab from the Home screen,

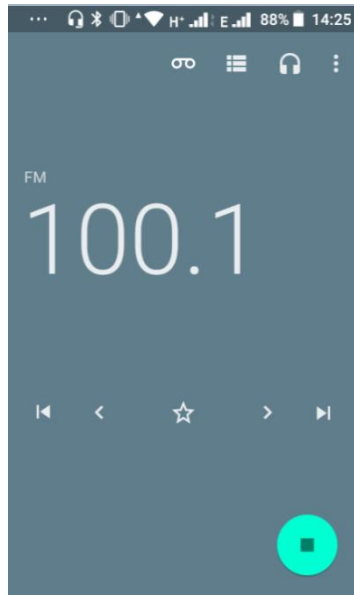

then touch **FM Radio**.



- Touch  and automatic scanning search is activated for FM channels. You can use the buttons in the lower of the screen to move ahead and back through channels.
- Touch the star icon to save a channel to favourites.
- Touch the  icon when listening to the radio and you can start recording or listen to previous recordings.
- Touch  to close the radio.
- Touch  icon and the radio will play outloud.

- To listen to FM radio in the background touch the back key and you will be returned to the phone menu and can use other applications while you listen to the radio.

13 Music

Using this menu, you can play music files stored on the microSD card and on your phone. Music files can be downloaded from computer to microSD card using a USB cable. To access this function, touch the





Application tab from the Home screen, then touch **Music**. You will find five categories in which all songs are classified: Artists, Albums, Songs, Playlists and Folders. Slide left and right to view all.

Touch the  button to find specific music you wish to play.

14 Google Play Store

Google Play store is an online software store where you can download and install applications and games to your android powered phone.

To open Google Play Store:

- Touch the Application tab form the Home screen, then touch  **Play Store**
- For the first time you access Google Play Store, a screen with terms of service pops up for your attention, touch **Accept** to continue
- Touch  and select Help & Feedback to enter Google Play Store help page for more information on this function.

15 Google Duo

Google Duo enables you to video chat with your contacts. To access this function, touch the Application tab from the Home screen, then

touch **Google Duo** . Follow the instructions in the app to enable this function.

16 Files

To access this function, touch the Application tab from the Home screen, then touch **Files**. Files works with both microSD card and phone storage. File Manager displays all data stored on both microSD card and phone storage, including applications, media files; videos, pictures or audios you have captured; other data transferred via Bluetooth, USB cable, etc.

When you download an application from PC to microSD card, you can locate the application on Files, then touch it to install it in your phone. Files allows you to perform and be efficient with the following common operations: create (sub) folder, open folder/ file, view, rename, move, copy, delete, play, share, etc.

17 Sound Recorder

To access this function, touch the Application tab from the Home

screen, then touch **Sound Recorder** . This function allows you to make recordings.

18 Settings

Pull down the Notification panel and touch the Settings icon  to access **Settings**.

18.1 Network and Internet

- **Wi-Fi:** You can access the internet on your phone using Wi-Fi without using your SIM card if you are in range of a wireless network. You need to connect your device to a wireless network to enable this. For instructions on how to set-up and use Wi-Fi please refer to **5. Wi-Fi**.
- **Mobile network**
Mobile data: touch to switch on.
Roaming: touch the switch to enable data services when roaming.
App data usage: shows how much data has been used for a certain time period.

Advanced settings:

Mobile data always online: touch to switch on/off

Enhanced 4G LTE Mode: when turned on it will improve communications

Preferred network type: will default to operator selection. Select another option if you wish to change.

Wi-Fi calling options: these are available if supported by your network operator.

Automatically select network: Your phone will select the network you have access to.

Access Point Names: APN's are settings for data and will default to operator selection. Some operators may send an automatic configuration text for these settings.

Data usage: allows you to monitor and set a data usage warning for your phone. Note data usage is measured by your phone. Your network operator may measure it differently.

- **Hotspot & tethering:** This option allows the sharing of your phone's mobile data connection via USB or Bluetooth. To share

your data via USB touch the  beside USB tethering.

To share via Bluetooth touch  beside Bluetooth tethering.

In the option **Wi-Fi hotspot** you can set options such as how long to keep the hotspot active, set up Wi-Fi hotspot, see how users are connected to your phone, block users from connecting to your phone and whitelist devices.

- **Aeroplane mode:** This mode disables all wireless connections in your phone including Wi-Fi, Bluetooth and Cellular.
- **VPN:** Virtual Private Networks (VPNs) allow you to connect to a secure local network from an external network. To add a VPN touch **Settings > Network & Internet > VPN** then touch . In the screen that opens follow the instructions from your network administrator to set up each component of the VPN settings.

Touch **SAVE**. The VPN is added to the list on the VPN settings screen. Note before adding a VPN you need to set a lock screen pattern, PIN code or password for your phone.

- **Private DNS:** Provides the options for off / Automatic / Private DNS

18.2 Connected devices

- **Bluetooth:** The Bluetooth function enables your phone to exchange data with other Bluetooth supported devices. This menu allows you to pair a Bluetooth device to your phone and manage connected devices. Please refer to section 6. **Bluetooth** on how to set-up and use Bluetooth.
- **Printing:** Your phone supports wireless printing to enabled printers. Use the Default print service or touch  to set up a new print service.

18.3 Apps and notifications

This setting allows you to view details about the installed applications on your phone, manage their data and force them to stop, and to set whether you want to permit installation of applications that you obtain from websites and other sources.

18.4 Battery

This screen displays battery usage data since the phone was last connected to a power supply. You can set it to show % battery usage in the status bar, set the phone

screen power save in standby mode, choose if you wish to enable batter saver mode among other settings.

18.5 Display

This screen allows you to adjust the brightness level of your phone's screen, set wallpaper, set the phone to sleep mode, auto rotate the display, change font size, size of how items on screen are shown (smaller or larger), set screensaver and font style. Simply touch the option and follow the instructions for your chosen settings.

18.6 Scheduled power on / off

Select this option to activate automated power on / off.

18.7 Navigation bar

Allows you to customise the navigation bar for your phone.

18.8 Audio Profiles

This screen enables you to adjust settings for Media, Alarms, Ring volume. You can also set options for vibrate, Do Not Disturb preferences, choose ringtone for calls. This screen also allows you to enable/disable other sounds and vibrations such as dial pad times, screen locking, charging, touch, vibrate on tap and sound enhancement.

18.9 Storage

This setting allows you to monitor the total and available space on your phone and your microSD card. Touch **Internal shared storage** then **FREE-UP SPACE** using Google's Files Go here if you wish to.

18.10 Security and location

This menu allows you to view the security status for your device.

- Google Play Protect: checks apps and your phone for harmful behaviour.

- Find My Device: touch to switch on to locate your phone.
- Security update: touch to check your phone's current software version and check for updates.

You can set device security options for your phone such as screen lock, Face Lock and Smart Lock.

Screen lock: choose how to lock your screen. Touch to choose Lock screen preferences. Touch to choose Face Lock.

Privacy

- Location: choose a mode for location access including High accuracy (uses GPS, Wi-Fi, Bluetooth or mobile networks), battery saving (Wi-Fi, Bluetooth or mobile networks) or device only (GPS used only).
- Show passwords: Touch the switch to display passwords as you type.
- Device admin apps: Touch to view or deactivate your phone's administrators.
- SIM card lock: Touch to lock your SIM card

- Encryption & credentials: View if your phone is encrypted. **Storage type** displays Storage of your phone. Touch **Trusted credentials** to view CA certificates. **User credentials** allows you to view and modify stored credentials. **Install from SD card** allows you to install encrypted certificates from the SD card. Touch **Clear credentials** to remove all credentials.
- Touch **Screen Pinning** to activate this function.

18.11 Users & accounts

This allows you to add, remove and manage your email and other accounts.

- Add account: touch to add an account for selected app.
- Automatically sync data: touch the switch to enable apps to refresh data automatically.

18.12 Accessibility

Use this to manage any accessibility options you have installed on your phone.

- Text-to-speech output: Select/set options as required for Google voice typing.
- Font size: touch to set text to smaller/larger size.
- Display size: choose the size of how items on screen are shown (smaller or larger).
- Magnification: touch to turn on/off the zoom in/out function by triple tapping the phone's screen.
- Large mouse cursor: touch to enable.
- Remove animations: touch to enable.
- Dwell timing: touch to enable
- Auto-rotate screen: Touch to switch on/off.

- Touch & hold delay: This allows you to set how long you need to hold your touch down before it registers. Touch to set Touch & hold to Short, Medium, Long.
- Vibration: Select the option/s you prefer.
- Mono audio: touch the switch to allow/disallow combining channels when playing audio.
- Captions: Touch to activate/deactivate captions for phone screen.
- High-contrast text: Touch to switch on/off.
- Colour correction: Touch to adjust colour mode.
- Colour inversion: Touch to adjust background/text colour.

18.13 Digital Wellbeing and parental controls

Digital Wellbeing: This menu allows you to view and set preferences for managing your smartphone and wellbeing such as screen-time usage. You can set timers for app usage, pause distracting apps when you need to focus and reduce interruptions.

Parental controls: Allows you to set up parental controls using Google Family Link.

18.14 Google

This setting provides Google account and services setting options.

18.15 System

About Phone: These screens will allow you to check for software status and updates for your phone. You can view legal information such as 3rd party licences, Google legal information. You can view Android software version, security patch level,

RAM, baseband version, kernel version and Build number of your phone's software.

- Languages & input: Touch to select your language. Set keyboard options (virtual and/or physical). Touch to access spell checker, set auto-fill service and add words to your own dictionary. Change your pointer speed if required. Text-to-speech output.
- Gestures: Allows you to set quick access to camera function. You can choose an option to prevent ringing.
- Date & time: Use Date & time settings to set your preferences for how time and date are displayed on your phone.
- Backup: Touch and switch on to automatically back up your phone's settings and other app data to Google Servers with your Google account. If you choose to replace your phone the settings and data you have backed up are restored to your new phone the first time you sign in with your Google account. If you mark this option a range of settings and data are back-up including Wi-Fi passwords, bookmarks, applications list and most of the settings that you configure with the Settings application. If you unmark this option your settings will not be backed-up and any existing back-ups are deleted from Google Servers.
- Reset Wi-Fi, mobile & Bluetooth: Touch and press to reset Wi-Fi, mobile and Bluetooth to reset all network settings.
- Reset App preferences: Touch and press to reset all apps settings including disabled apps, app notifications etc.
- Erase all data (factory reset): Touch to erase all your personal data from internal phone storage including Google account information, other accounts, your system and application settings and any downloaded applications. Resetting the phone

will not erase system software updates that have been downloaded or any files on the MicroSD card.

- System update: Touch to check your phone's current software version and check for updates.